

FL-FLZ

Αφυγραντές Standard



Αυτές οι μονάδες ενδείκνυνται για σιδερωτήρια, για βιβλιοπωλεία, εργοστάσια τυροκομικών, υπόγεια δωμάτια, κελάρια και εργοστασιακούς χώρους όπου υπάρχει υψηλή υγρασία.

FL dehumidifiers series are high-performances units especially designed for industrial or commercial purposes where humidity level should be controlled or water vapour condensation should be prevented. These units are particularly indicated for archives, ironing rooms, bookstores, cheese factories, underground rooms, cellars and industrial sites where high humidity level is present. This series comprises 3 basic models which cover a capacity range from 564 to 940 l/24h. FL units are designed for easy maintenance and service, each part being readily accessible and, when required, easily replaceable thus reducing service and maintenance costs.

VERSIONS

- Hot gas defrost version (s): Beside the components of the standard version, the unit is supplied with a solenoid valves set for the hot gas injection used to defrost the evaporator in case of severe working conditions. The hot gas injection allows a faster defrost time and this permits to use this unit in areas with lower temperatures (down to 1°C) compared to the standard version.
- Version with temperature control FLZ: These versions are supplied with a remote condenser and are used in those applications where it is necessary the simultaneous control of temperature and humidity: Dehumidification mode: the internal condenser is activated; the unit dehumidifies and heats up the room temperature; Cooling mode: the remote condenser is activated; the unit dehumidifies and cools down the room temperature.

ACCESSORIES

- Integrated mechanical hygostat
- Remote mechanical hygostat
- Remote mechanical hygostat + thermostat
- Available static pressure 200 Pa
- Floor trolley version
- Stainless steel frame
- Air filter with frame for ducted installation

Επισκεφτείτε μας στο www.tsitsos.gr

Mod.		FL560	FL560S	FL740	FL740S	FL940	FL940S
Moisture removed ⁽¹⁾	l/24h	564,1	564,1	738,5	738,5	937,3	937,3
Nominal input power ⁽²⁾	kW	8,7	8,7	11,3	738,5	14,9	14,9
Max input power ⁽²⁾	kW	9,5	9,5	12,4	12,4	16,4	16,4
Nominal input current ⁽¹⁾	A	15,5	15,5	18,7	18,7	24,7	24,7
Max input current ⁽²⁾	A	17	17	20,5	20,5	27,4	27,4
Air flow	m ³ /h	5150	5150	6850	6850	8200	8200
Available static pressure	Pa	50	50	50	50	50	50
Refrigerant		R407C	R407C	R407C	R407C	R407C	R407C
Sound pressure ⁽³⁾	dB(A)	72	72	73	73	74	74
Temperature operating range	°C	5-35	1-35 ⁽⁶⁾	5-35	1-35 ⁽⁶⁾	5-35	1-35 ⁽⁶⁾
Humidity operating range	%	50-99	50-99	50-99	50-99	50-99	50-99
Weight	Kg	390	390	412	412	439	439
Power supply	V/Ph/Hz	400/3--N/50					

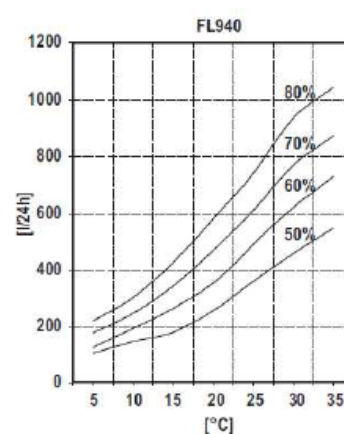
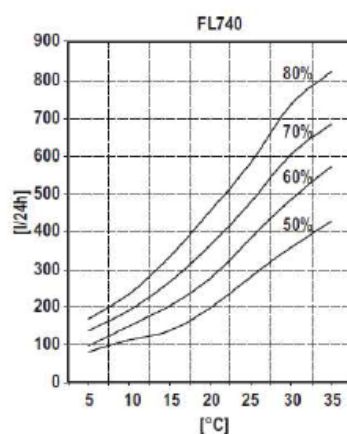
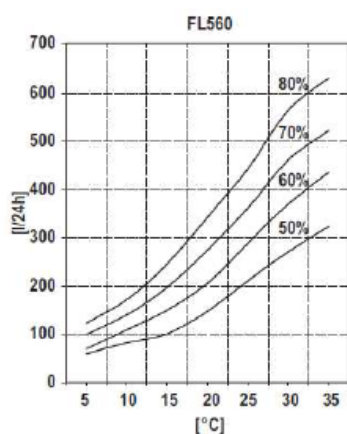

- ⁽¹⁾ Performances refer to the following conditions: room temperature 30°C; relative humidity 80%.
⁽²⁾ Performances refer to the following conditions: room temperature 35°C; relative humidity 80%.
⁽³⁾ Sound pressure level measured at 1 mt from the unit in free field conditions according to ISO 3740.
⁽⁴⁾ Performances refer to the following conditions: room temperature 30°C; relative humidity 80%; ambient temperature 35°C.
⁽⁵⁾ Performances refer to the following conditions: room temperature 35°C; relative humidity 80%; ambient temperature 35°C.
⁽⁶⁾ S versions with hot gas defrost only.

Mod.		FLZ560	FLZ560S	FLZ740	FLZ740S	FLZ940	FLZ740S
Moisture removed ⁽¹⁾	l/24h	564,1	564,1	738,5	738,5	937,3	937,3
Input power ⁽¹⁾	kW	9,1	9,1	11,7	11,7	15,3	15,3
Input current ⁽¹⁾	A	19,1	19,1	22,3	22,3	28,5	28,5
Cooling capacity ⁽²⁾	kW	26,5	26,5	34,6	34,6	43,8	43,8
Input power ⁽³⁾	kW	8,9	8,9	11,4	11,4	15	15
Maximum input power ⁽⁴⁾	kW	9,9	9,9	12,8	12,8	16,8	16,8
Maximum input current ⁽⁵⁾	A	20,5	20,5	24,1	24,1	31	31
Air flow	m ³ /h	5150	5150	6850	6850	8200	8200
Available static pressure	Pa	50	50	50	50	50	50
Refrigerant		R407C	R407C	R407C	R407C	R407C	R407C
Sound pressure ⁽⁶⁾	dB(A)	72	72	73	73	74	74
Temperature operating range	°C	5-35	1-35 ⁽⁶⁾	5-35	1-35 ⁽⁶⁾	5-35	1-35 ⁽⁶⁾
Humidity operating range	%	50-99	50-99	50-99	50-99	50-99	50-99
Weight	Kg	390	390	412	412	439	439
Power supply	V/Ph/Hz	400/3~+N/50					

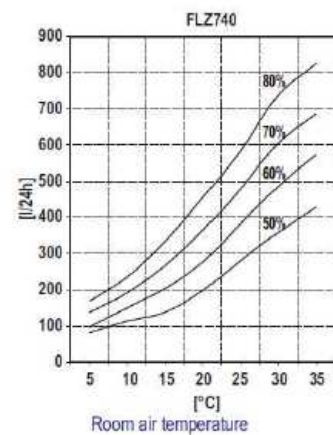
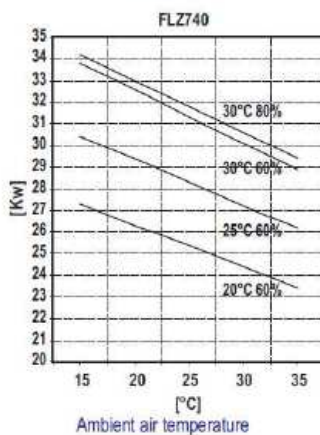
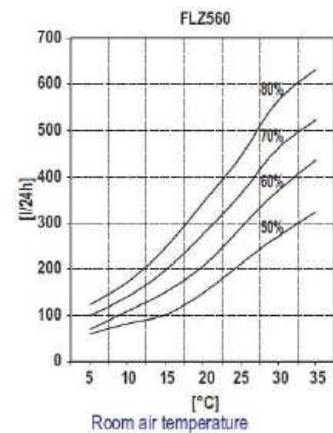
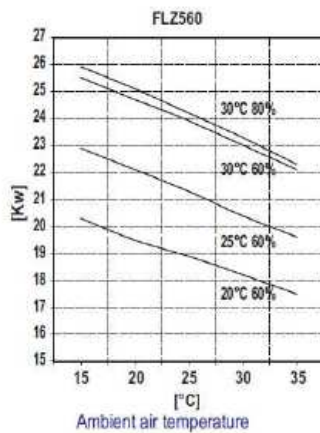

⁽¹⁾ Performances refer to the following conditions: room temperature 30°C, relative humidity 80%.
⁽²⁾ Performances refer to the following conditions: room temperature 35°C, relative humidity 80%.
⁽³⁾ Sound pressure level measured at 1 m from the unit in free field conditions according to ISO 3746.
⁽⁴⁾ Performances refer to the following conditions: room temperature 30°C, relative humidity 80%, ambient temperature 35°C.
⁽⁵⁾ Performances refer to the following conditions: room temperature 35°C, relative humidity 80%, ambient temperature 35°C.
⁽⁶⁾ S versions with hot gas defrost only.

ΕΠΙΣΚΕΦΤΕΙΤΕ ΜΑΣ ΣΤΟ www.tsitsos.gr

REFRIGERANT CONNECTIONS FOR Z VERSIONS

The Z version units are supplied of a remote condenser and they need to be connected with the dehumidifier through refrigerant lines.

The remote condenser is equipped of a main switch and a fan speed control. Please refer to the following paragraphs for the refrigerant connections and to the next chapter for the electrical ones.

Line path and max. distance between the sections.

For the units in Z version with separate sections, the course of the refrigerant pipes is influenced by the location of the sections themselves and by the structure of the building. The pipes have to be in any case as short as possible, so that can contain the charge lacks and reduce the quantity of

refrigerant present in the refrigerant circuit. The connections must be isolated and their length must not exceed 30 m. Our Company is available for any information even in case of applications not included in the limits indicated above.

Dehumidifier lower than the condenser

Install a liquid trap on suction line at the evaporator outlet with the same height of the evaporator so that liquid refrigerant, when the system is not running, will not fall into compressor;

On horizontal suction pipelines a minimum 1% slope should be allowed in order to let the oil easily come back to compressor.

Dehumidifier higher than the condenser

On the rising vertical pipes, oil traps should be fitted every 6 metres to allow oil circulation in the system;

Install a collection pit immediately downstream from the bulb of the thermostatic valve;

On horizontal suction pipelines a minimum 1% slope should be allowed in order to let the oil easily come back to compressor. Pipelines diameter can be read in Table II depending on the unit size and the length of refrigerant pipelines.

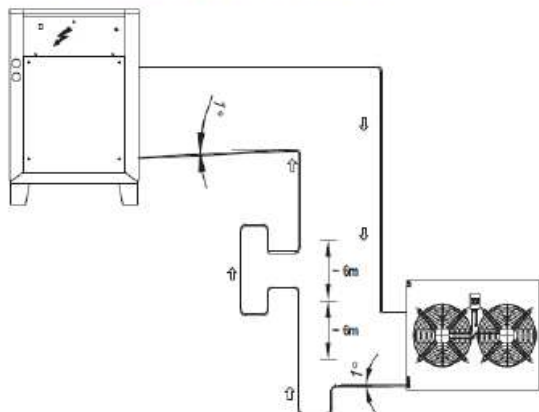

Dehumidifier higher than the condenser

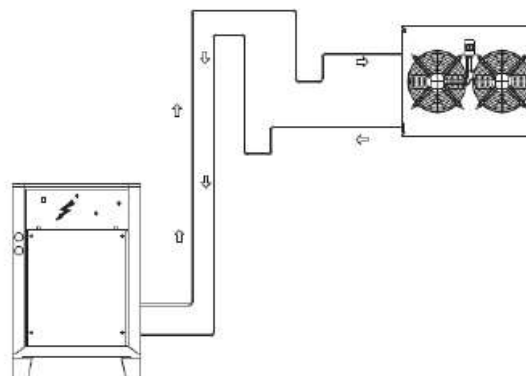

Dehumidifier lower than the condenser

Refrigerant diameters lines for version FLZ						
Distance (m)	10		20		30	
	Gas (mm)	Liquid (mm)	Gas (mm)	Liquid (mm)	Gas (mm)	Liquid (mm)
560	22	15,88	22	18	28	18
740	28	15,88	28	18	28	22
940	35	15,88	35	18	35	22

Liquid line refrigerant charge			
Liquid line diameter	Refrigerant charge g/m	Liquid line diameter	Refrigerant charge g/m
15,88 (mm)	175	22 (mm)	360
18 (mm)	220	---	---

Cooling capacity correction factors				
Mod.	Refr. Line 0 (m)	Refr. Line 10 (m)	Refr. Line 20 (m)	Refr. Line 30 (m)
FLZ	1	0,98	0,96	0,95

FRAME

All FL units are made from hot-galvanised thick sheet metal, painted with polyurethane powder enamel at 180°C to ensure the best resistance against the atmospheric agents. The frame is self-supporting with removable panels. The drip tray is present standard in all FL units and it's in stainless steel. The colour of the units is RAL 7035.

REFRIGERANT CIRCUIT

The refrigerant gas used in these units is R407C. The refrigerant circuit is made by using international primary brands components and according to ISO 97/23 concerning welding procedures. The refrigerant circuit includes: sight glass, filter drier, thermal expansion valve with external equalizer, Schrader valves for maintenance and control, pressure safety device (according to PED regulation).

COMPRESSOR

The compressor is scroll type with crankcase heater and thermal overload protection by a klixon embedded in the motor winding. It's mounted on rubber vibration dampers and, by request, it can be supplied with some jackets to reduce the noise (accessory). The crankcase heater, when present, is always powered when the compressor is in stand-by. The inspection is possible through the frontal panel of the unit.

CONDENSER AND EVAPORATOR

The condensers and evaporators are made of copper pipes and aluminium fins. The diameter of the copper pipes is 3/8" and the thickness of the aluminium fins is 0,1 mm. The tubes are mechanically expanded into the aluminium fins to improve the heat exchange factor. The geometry of these condensers guarantees a low air side pressure drop and then the use of low rotation (and low noise emission) fans. All the units have a stainless steel drip tray. Besides this, each evaporator is supplied of a temperature probe used as automatic antifreeze probe.

FANS

The fan is centrifugal type. It's statically and dynamically balanced and supplied complete of the safety fan guard according to EN 294. It's mounted on the unit frame by interposition of rubber vibration dampers.

The electric motor is at 4 poles (about 1500 rpm). Connected to the fan by belts and pulleys and it's equipped of an integrated thermal overload protection. The protection class of the motors is IP 54.

AIR FILTER

It's supplied standard with the unit. It's made of filtering material in synthetic fibre without electrostatic charge. It can be removed for differential disposal, class G3, according to EN 779:2002.

MICROPROCESSOR

All FL units are supplied standard with microprocessor controls. The microprocessor controls the following functions: compressor timing, automatic defrost cycles, the management of fresh and exhaust air, post heating valve and alarms. An appropriate LCD display shows the operation mode of the unit, set point and alarms

ELECTRIC BOX

The electric switch board is made according to electromagnetic compatibility norms CEE 73/23 and 89/336. The accessibility to the board is possible after removing the front panel of the unit and the OFF positioning of the main switch. In all FL units are installed, standard, the compressors sequence relay which disables the operation of the compressor in case the power supply phase sequence is not the correct one (scroll compressors in fact, can be damaged if they rotate reverse wise). The following components are also standard installed: main switch, magnetic-thermal switches (as a protection of the fans), compressors fuses, control circuit automatic breakers, compressor contactors. The terminal board is also supplied with voltage free contacts for remote ON-OFF.

CONTROL AND PROTECTION DEVICES

All units are supplied with the following control and protection devices: defrost thermostat, which signals to the microprocessor control that a defrost cycle is needed and controls its termination, high pressure switch with manual reset, low pressure switch with automatic reset, high pressure safety valve, compressor thermal overload protection, fans thermal overload protection.

TEST

All the units are fully assembled and wired at the factory, carefully evacuated and dried after leak tests under pressure and then charged with refrigerant R407C. They are all fully operational tested before shipment. They all conform to European Directives and are individually marked with the CE label and provided with Conformity Declaration

REMOTE CONDENSER

The remote condensers are made of copper pipes and aluminium fins. The diameter of the copper pipes is 3/8" and the thickness of the aluminium fins is 0,1 mm. The tubes are mechanically expanded into the aluminium fins to improve the heat exchange factor. The geometry of these condensers guarantees a low air side pressure drop and then the use of low rotation (and low noise emission) fans. The fans are axial type with aluminium aerofoil blades complete of the safety fan guard. The protection class of the motors is IP 54. Furthermore the remote condenser is supplied of the low ambient condensing pressure control. This device controls the cooling circuit condensing pressure at different ambient temperatures, to keep it correct.

Mod.	FL560	FL740	FL940	FLZ560	FLZ740	FLZ940
Integrated mechanical hygrostat	○	○	○	-	-	-
Remote mechanical hygrostat	○	○	○	-	-	-
Remote mechanical hygrostat + thermostat	-	-	-	○	○	○
Available static pressure 200 Pa	○	○	○	○	○	○
Floor trolley version	○	○	○	-	-	-
Stainless steel frame	○	○	○	○	○	○
Air filter with frame for ducted installation	○	○	○	○	○	○
Condensate discharge pump	○	○	○	○	○	○
Horizontal air discharge	○	○	○	○	○	○

● Standard, ○ Optional, - Not available.

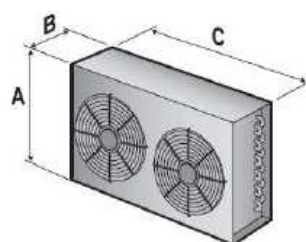
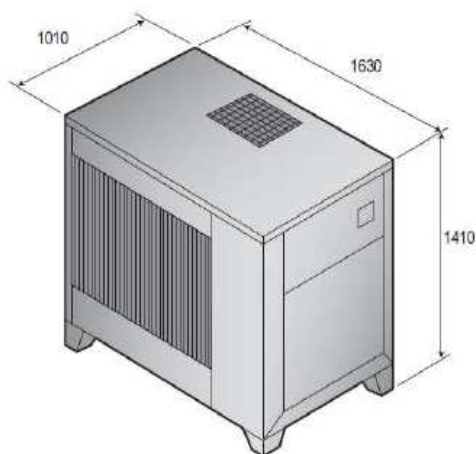
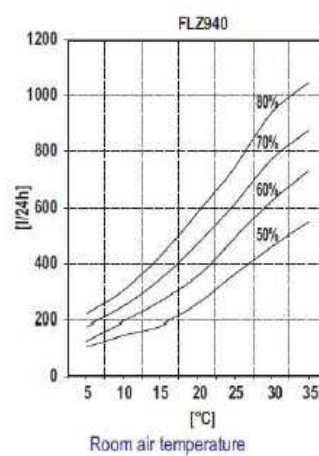
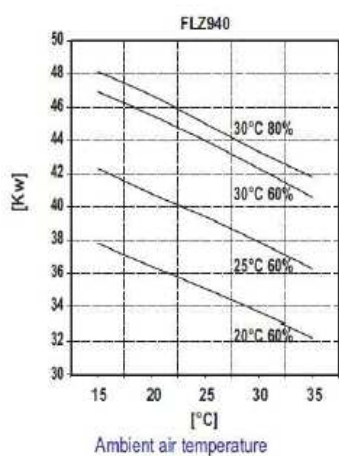

Mod.	A (mm)	B (mm)	C (mm)	Kg
560	810	480	1292	65
740	810	480	1292	65
940	1010	480	1292	90

www.hidros.it

Επισκεφτείτε μας στο www.tsitsos.gr